

B20E

6x6
Articulated Dump Truck

Low Ground Pressure | Mk 3



Stage V Certified

- Gross Power: 170 kW (228 hp)
- Heaped Capacity: 11 m³ (14,5 yd³)
- Rated Payload: 18 000 kg (39 683 lbs)
- Operating Weight: 34 493 kg (76 044 lbs)

BELL

<p>ENGINE</p> <p>Manufacturer Mercedes Benz (MTU)</p> <p>Model OM934LA / 4R 1000</p> <p>Configuration Inline 4, turbocharged and intercooled.</p> <p>Gross Power 170 kW (228 hp) @ 2 200 rpm</p> <p>Net Power 161 kW (216 hp) @ 2 200 rpm</p> <p>Gross Torque 900 Nm (664 lbf) @ 1 200 -1 600 rpm</p> <p>Displacement 5,1 litres (311 cu.in)</p> <p>Auxiliary Brake Jacobs engine brake</p> <p>Fuel Tank Capacity 195 litres (52 US gal)</p> <p>AdBlue® Tank Capacity 31 litres (8,2 US gal)</p> <p>Certification OM934LA meets EU Stage V emissions regulations.</p>	<p>Torque Control Hydrodynamic with lock-up in all gears.</p> <p>TRANSFER CASE</p> <p>Manufacturer Kessler</p> <p>Series W1400</p> <p>Layout Remote mounted</p> <p>Gear Layout Three in-line helical gears</p> <p>Output Differential Interaxle 33/67 proportional differential. Automatic inter-axle differential lock.</p> <p>AXLES</p> <p>Manufacturer Bell</p> <p>Model 15T</p> <p>Differential High input limited slip differential with spiral bevel gears</p> <p>Final Drive Outboard heavy duty planetary on all axles.</p> <p>BRAKING SYSTEM</p> <p>Service Brake Dual circuit, full hydraulic actuation wet disc brakes on front and middle axles.</p> <p>Maximum brake force: 173 kN (38 892 lbf)</p> <p>Park & Emergency Spring applied, air released driveline mounted disc.</p> <p>Maximum brake force: 193 kN (43 388 lbf)</p> <p>Auxiliary Brake Automatic Jacobs engine brake. Automatic, adjustable, integral, hydrodynamic transmission retarder. Output shaft speed dependent.</p>	<p>Total Retardation Power Continuous: 178 kW (239 hp) Maximum: 584 kW (783 hp)</p> <p>WHEELS</p> <p>STANDARD: Type Flotation</p> <p>Tyre 800/45 R 30.5</p> <p>OPTION: Type Radial Earthmover</p> <p>Tyre 20.5 R 25</p> <p>FRONT SUSPENSION Semi-independent, leading A-frame supported by hydro-pneumatic suspension struts.</p> <p>REAR SUSPENSION Pivoting walking beams with laminated rubber suspension blocks.</p> <p>HYDRAULIC SYSTEM Full load sensing system serving the prioritized steering, body tipping and brake functions. A ground-driven, load sensing emergency steering pump is integrated into the main system.</p> <p>Pump Type Variable displacement load sensing piston</p> <p>Flow 155 l/min (41 gal/min)</p> <p>Pressure 27 MPa (3 916 psi)</p> <p>Filter 5 microns</p> <p>STEERING SYSTEM Double acting cylinders, with ground-driven emergency steering pump.</p> <p>Lock to lock turns 4,32</p> <p>Steering Angle 45°</p>	<p>DUMPING SYSTEM</p> <p>Two double-acting, single stage, dump cylinders.</p> <p>Raise Time 10 s</p> <p>Lowering Time 5,5 s</p> <p>Tipping Angle 70° standard, or any lower angle programmable</p> <p>PNEUMATIC SYSTEM</p> <p>Air drier with heater and integral unloader valve, serving park brake and auxiliary functions.</p> <p>System Pressure 810 kPa (117 psi)</p> <p>ELECTRICAL SYSTEM</p> <p>Voltage 24 V</p> <p>Battery Type Two AGM (Absorption Glass Mat) type.</p> <p>Battery Capacity 2 X 75 Ah</p> <p>Alternator Rating 28V 80A</p> <p>VEHICLE SPEEDS</p> <table border="1"> <tr> <td>1st</td> <td>6 km/h</td> <td>4 mph</td> </tr> <tr> <td>2nd</td> <td>15 km/h</td> <td>9 mph</td> </tr> <tr> <td>3rd</td> <td>19 km/h</td> <td>12 mph</td> </tr> <tr> <td>4th</td> <td>27 km/h</td> <td>17 mph</td> </tr> <tr> <td>5th</td> <td>36 km/h</td> <td>22 mph</td> </tr> <tr> <td>6th</td> <td>47 km/h</td> <td>29 mph</td> </tr> <tr> <td>R</td> <td>6 km/h</td> <td>4 mph</td> </tr> </table> <p>CAB</p> <p>ROPS/FOPS certified 71 dBA internal sound level measured according to ISO 6396.</p>	1st	6 km/h	4 mph	2nd	15 km/h	9 mph	3rd	19 km/h	12 mph	4th	27 km/h	17 mph	5th	36 km/h	22 mph	6th	47 km/h	29 mph	R	6 km/h	4 mph
1st	6 km/h	4 mph																						
2nd	15 km/h	9 mph																						
3rd	19 km/h	12 mph																						
4th	27 km/h	17 mph																						
5th	36 km/h	22 mph																						
6th	47 km/h	29 mph																						
R	6 km/h	4 mph																						
<p>TRANSMISSION</p> <p>Manufacturer Allison</p> <p>Model Standard non-retarder: 3000P ORS Optional retarder: 3000PR ORS</p> <p>Configuration Fully automatic planetary transmission with integral retarder.</p> <p>Layout Engine mounted</p> <p>Gear Layout Constant meshing planetary gears, clutch operated</p> <p>Gears 6 Forward, 1 Reverse</p> <p>Clutch Type Hydraulically operated multi-disc</p> <p>Control Type Electronic</p>																								

Load Capacity & Ground Pressure

OPERATING WEIGHTS		GROUND PRESSURE		LOAD CAPACITY		OPTION WEIGHTS	
UNLADEN	kg (lb)	LADEN (3" sinkage)		BODY	m³ (yd³)	kg (lb)	
Front	8 740 (19 268)	800/45 R 30.5	kPa (Psi)	Struck Capacity	9 (11)	Bin liner	778 (1 715)
Middle	4 016 (8 854)	Front	72 (10)	SAE 2:1 Capacity	11 (14,5)	Tailgate	633 (1 396)
Rear	3 737 (8 239)	Middle	95 (14)	SAE 1:1 Capacity	13,5 (17,5)	Extra wheelset	
Total	16 493 (36 361)	Rear	95 (14)	SAE 2:1 Capacity		800/45 R 30.5	338 (745)
LADEN		LADEN (No sinkage)		with Tailgate	11,5 (15)	Extra wheelset	
Front	10 540 (23 237)	20.5 R 25	kPa (Psi)			20.5 R 25	355 (783)
Middle	12 006 (26 469)	Front	215 (31)	Rated Payload	18 000 kg		
Rear	11 947 (26 338)	Middle	309 (45)		(39 683 lbs)		
Total	34 493 (76 044)	Rear	309 (45)				

Dimensions

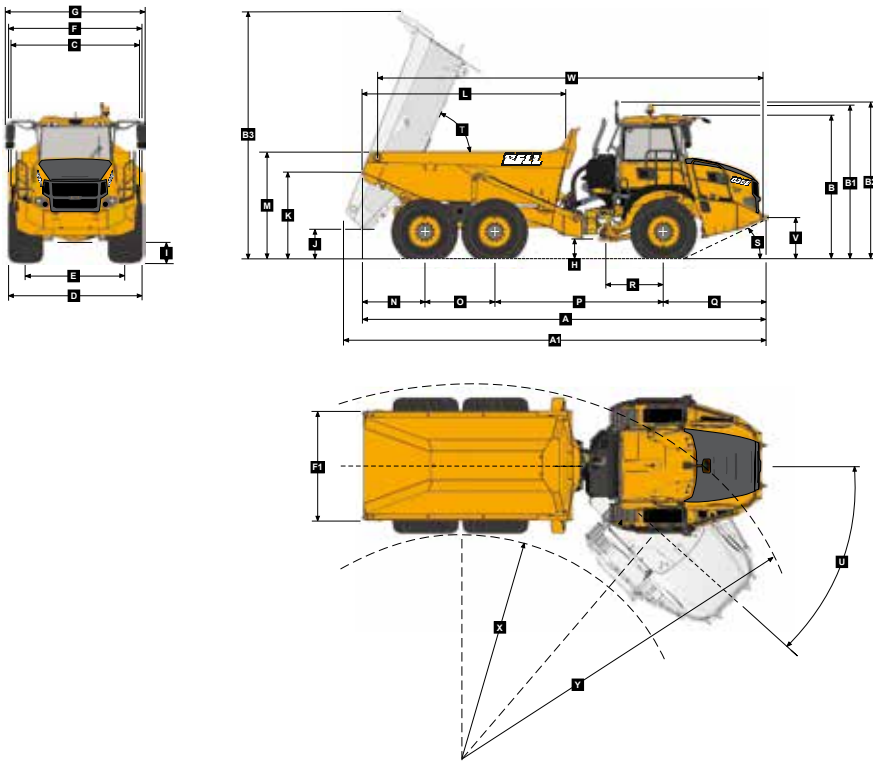

Machine Dimensions

A	Length - Transport Position	9271 mm (30 ft. 5 in)
A1	Length - Bin Fully Tipped	9560 mm (31 ft. 4 in)
B	Height - Transport Position	3385 mm (11 ft. 1 in)
B1	Height - Rotating Beacon	3619 mm (11 ft. 10 in)
B2	Height - Load Light	3702 mm (12 ft. 2 in)
B3	Bin Height - Fully Tipped	5742 mm (18 ft. 10 in)
C	Width over Mudguards	2984 mm (9 ft. 9 in)
D	Width over Tyres - 800/45-30.5	3102 mm (10 ft. 2 in)
D1	Width over Tyres - 20.5R25	2931 mm (9 ft. 7 in)
E	Tyre Track Width - 800/45-30.5	2312 mm (7 ft. 7 in)
E1	Tyre Track Width - 20.5R25	2399 mm (7 ft. 10 in)
F	Width over Bin	2540 mm (8 ft. 4 in)
F1	Width over Tailgate	2838 mm (9 ft. 4 in)
G	Width over Mirrors - Operating Position	3260 mm (10 ft. 8 in.)
H	Ground Clearance - Artic	498 mm (18,86 in.)
I	Ground Clearance - Front Axle	458 mm (17,48 in.)
J	Ground Clearance - Bin Fully Tipped	678 mm (26,38 in.)
K	Bin Lip Height - Transport Position	2067 mm (6 ft. 9 in.)
L	Bin Length	4709 mm (15 ft. 5 in.)
M	Load over Height	2537 mm (8 ft. 4 in.)
N	Rear Axle Centre to Bin Rear	1449 mm (4 ft. 9 in.)
O	Mid Axle Centre to Rear Axle Centre	1600 mm (5 ft. 2 in.)
P	Mid Axle Centre to Front Axle Centre	3865 mm (12 ft. 8 in.)
Q	Front Axle Centre to Machine Front	2357 mm (7 ft. 8 in.)
R	Front Axle Centre to Artic Centre	1361 mm (4 ft. 5 in.)
S	Approach Angle	27°
T	Maximum Bin Tip Angle	70°
U	Maximum Articulation Angle	45°
V	Front Tie Down Height	1041 mm (3 ft. 5 in)
W	Machine Lifting Centres	8845 mm (29 ft.)
X	Inner Turning Circle Radius-800/45-30.	3678 mm (12 ft. 1 in)
X1	Inner Turning Circle Radius-20.5R2	3763 mm (12 ft. 4 in.)
Y	Outer Turning Circle Radius-800/45-30.	7585 mm (24 ft. 11 in.)
Y1	Outer Turning Circle Radius-20.5R2	7499 mm (24 ft. 7 in.)

Grade Ability / Rimpull

1. Determine tractive force by finding intersection of vehicle mass line and grade line. NOTE: 2% typical rolling resistance is already assumed in chart and grade line.
2. From this intersection, move straight right across charts until line intersects rimpull curve.
3. Read down from this point to determine maximum speed attained at that tractive resistance.

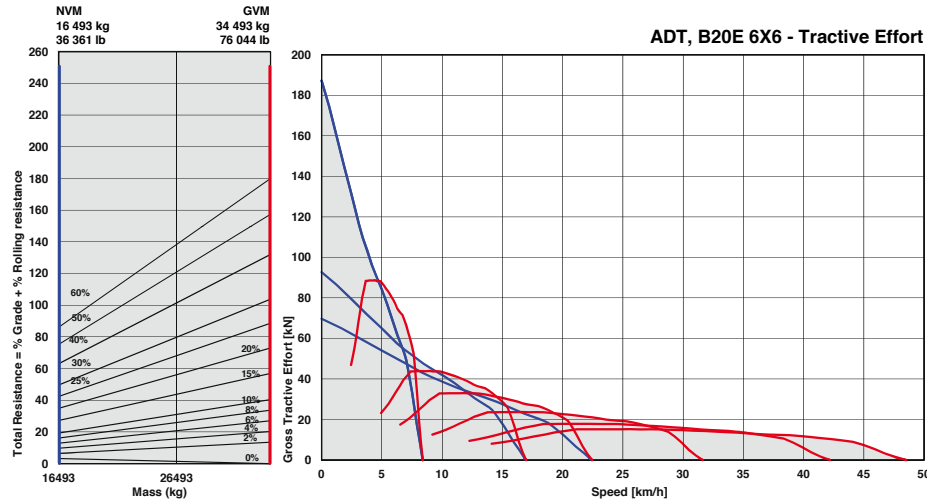

Retardation

1. Determine retardation force by finding intersection of vehicle mass line and grade line. NOTE: 2% typical rolling resistance is already assumed in chart and grade line.
2. From this intersection, move straight right across charts until line intersects the curve.
3. Read down from this point to determine maximum speed.

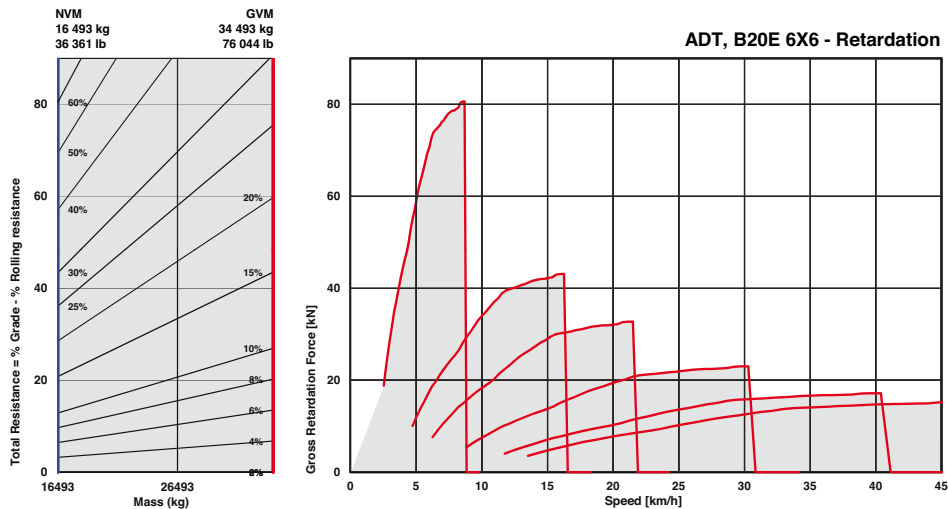

This curve is for a non-retarder transmission

Features and Options

● STANDARD ▲ OPTION

ENGINE

- Jacobs engine braking
- Dual element air cleaner with dust ejector valve
- Precleaner with automatic dust scavenging
- Water separator
- Serpentine drive belt with automatic tensioner
- Provision for fast fill

COOLING

- Crankshaft mounted electronically controlled viscous fan drive
- Fan guard

PNEUMATIC SYSTEM

- Engine-mounted compressor
- Air drier with heater
- Integral unloader valve

ELECTRICAL SYSTEM

- Battery disconnect
- Drive Lights
- Air Horn
- Reverse alarm
- ▲ White Noise reverse alarm
- Rotating Beacon
- Pitch Roll Sensor
- LED reverse lights
- ▲ LED Artic reverse lights
- ▲ Halogen Artic reverse lights

STEERING SYSTEM

- Bi-directional ground-driven secondary steering pump

CAB

- ROPS/FOPS certification
- Tilt cab
- Gas strut-supported door
- I-Tip programmable dump-body tip settings
- HVAC Climate control system
- AM/FM radio/CD player
- Rear window guard
- Wiper/washer with intermittent control
- Tilt and telescoping steering wheel
- Centre-mount air-suspension seat
- Halogen work Lights
- ▲ LED work lights
- ▲ Rotating beacon: seat belt installation
- ▲ Remote engine and machine isolation
- Remote battery jump start
- Retractable 3 point seat belt
- Heated seat
- Foldaway trainer seat with retractable seat belt
- 12-volt power outlet

CAB

- Cab utility bin (removable)
- Cup holder
- Cooled/heated lunch box
- Electric adjustable and heated mirrors
- Deluxe 10" colour LCD:
Speedometer / Fuel gauge /
Transmission oil temperature gauge /
Engine coolant temperature gauge /
LED function/warning indicators and audible alarm / Transmission gear selection /
Tachometer / Battery voltage / Hour meter /
Odometer / Fuel consumption / Tip counter /
Trip timer / Trip distance / Metric/English units /
Service codes/diagnostics.
- Backlit sealed switch module functions with:
Wiper control / Lights / Heated mirrors /
Retarding aggressiveness / Transfer case differential lock / Transmission gear hold /
Dump-body tip limit / Automatic dump-body tip settings / Airconditioner/Heater controls /
Preselected Speed Control.

DUMP BODY

- ▲ Dump-body mechanical lock - fully up
- Dump-body mechanical lock - partially up
- ▲ Body liner
- ▲ Tailgate
- ▲ Body heater
- ▲ Less dump body and cylinders

OTHER

- Automation Traction Control (ATC)
- Wet disc brakes
- 800/45 R 30.5 Low Ground Pressure tyres
- ▲ 20.5 R 25 Radial Earthmover tyres
- Remote grease banks
- ▲ Automatic greasing
- Onboard Weighing
- ▲ Load lights: stacks
- Reverse Camera
- ▲ Hand Rails
- Cab Peak
- ▲ High Pressure Hydraulic filter
- ▲ Fuel Heater
- Belly cover
- Cross member cover
- ▲ Remote transmission filters
- Fleetm@tic® Classic Package for 2 years
- ▲ Window smash button
- Electronic bonnet opening

All dimensions are shown in millimetres, unless otherwise stated between brackets.
Under our policy of continuous improvement, we reserve the right to change technical data and design without prior notice. Photographs featured in this brochure may include optional equipment.

BELL INTERNATIONAL: Tel: +27 (0)35-907 9431

E-mail: marketing@bellequipment.com

Web: www.bellequipment.com

 Tel: +61 (0)8-9355-2442

 Tel: +49 (0)6631 / 91-13-0

 Tel: +27 (0)11-928-9700

 Tel: +44 (0)1283-712862

 Tel: +33 (0)5-55-89-23-56

 Tel: +7-495-287-80-02

 Tel: (704) 655 2802

**Strong Reliable Machines
Strong Reliable Support**

BELL